

AC Driverless Dimmable LED T8 tube specification

Item: GNH-AC-T8-12

Dimension(mm): L1200*Φ28;

Power: 12W; 14W; 16W; 28W

Date: Dec 23th, 2014



I. Product introduction

Materials

Our T8 LED tubes use high quality SMD2835 LED light source and with full PC cover.

Characteristics

1. **Energy saving.** LED tube light can save you more than 60% in energy cost compare to conventional tube.
2. **High luminous efficiency.** Could reach be 120 lumen per watt.
2. **Long life and environmental protection.** LED tube light uses LEDs with long lifetime more than 50,000 hours. It has no ultraviolet radiation. It offers full environmental protection. It has no hazardous materials like mercury or lead entering the environment.
3. **Compatible.** Can be compatible with the electronic rectifier and inductance rectifier and easy for lamp retrofit.
4. **Good heat dissipation.** Low temperature maintained by unique heat dissipation mechanism.
5. **High Power Factor.** PF will be 0.9-0.97, and will be safer.
6. **Special design.** It works without typical driver. These LEDs can be connected directly to normal power supplies(usually 110V at 60 HZ or 240V at 50HZ).
7. **Healthy to eyes.** Instant start, no flickering, no humming. Aluminum isolation avoids EMC electronic wave disturbance.
8. **Variety of designs and constant innovation.** We manufacture standard and dimmable LED tubes, sound and movement activated dimmable LED tubes in different lengths.

II. Specifications, parameters

1. Dimensional Drawing:

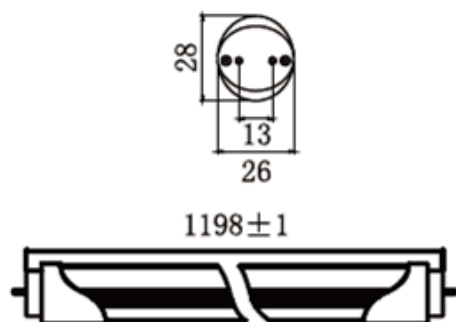

All dimension units are millimeter.

All dimension tolerance is ± 1 mm unless otherwise noted.

2. LED lighting technical parameters (***) Note: Different CCT LEDS has different optical properties. The deviation is less than 5% (***)

Model No.	LED No. (pcs)	Voltage(AC)	Size (MM)	Power	CCT	LED style	Flux(LM)	Beam angle	CRI(Ra)
GNH-AC-T8-12-12W	84	AC110	28*28*589 mm	12W	28*28*1198 mm	Epistar SMD2835	1440	270°	70-80
GNH-AC-T8-12-14W	168	AC110	28*28*894 mm	14W	28*28*1198 mm	Epistar SMD2835	1680	270°	70-80
GNH-AC-T8-12-16W	168	AC110	28*28*1198 mm	16W	28*28*1198 mm	Epistar SMD2835	1920	270°	70-80
GNH-AC-T8-12-18W	168	AC110	28*28*1198 mm	16W	28*28*1198 mm	Epistar SMD2835	2160	270°	70-80

3. Photometric drawing (just for reference)

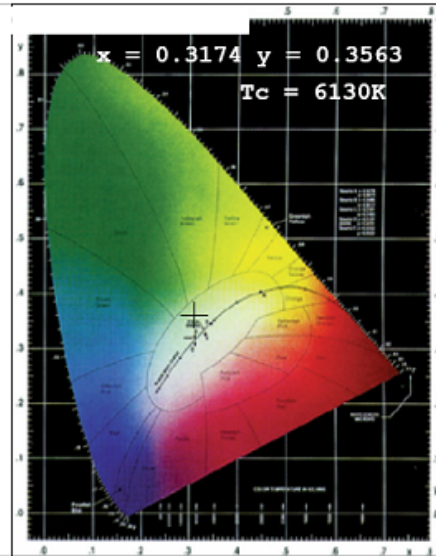
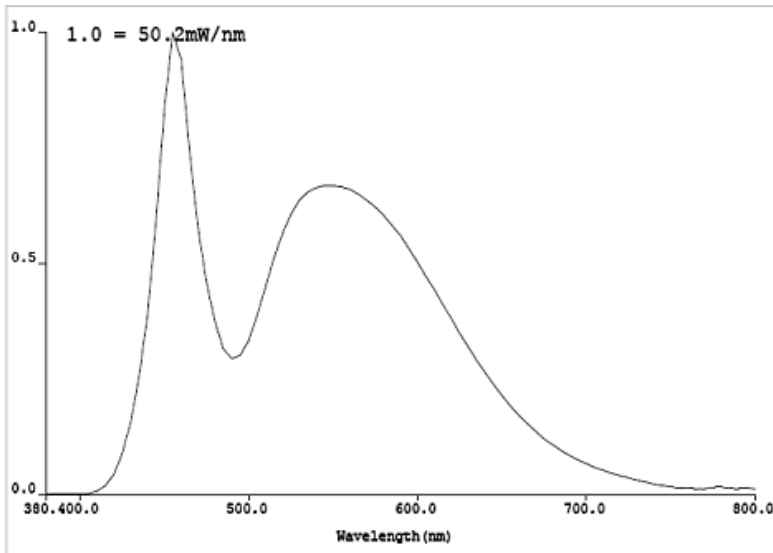

Illuminance Maintenance

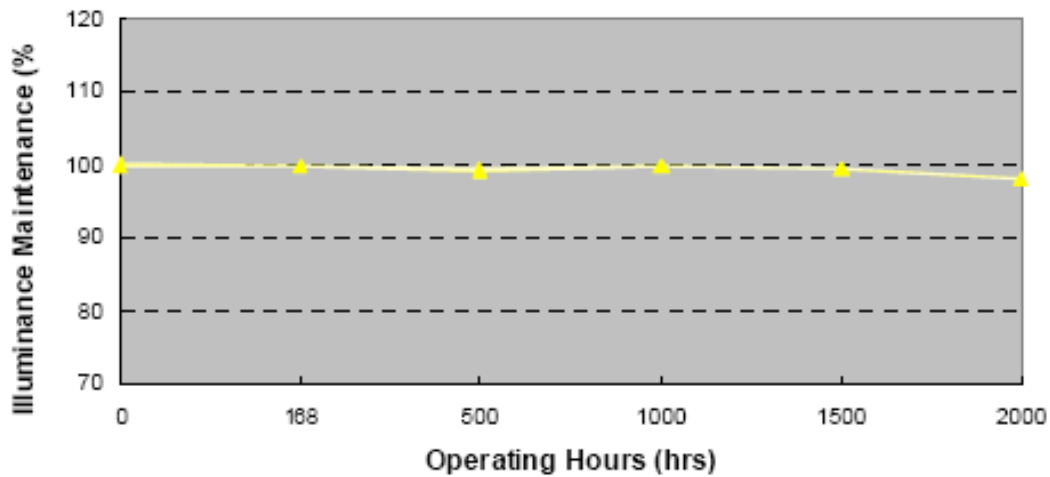

4. External Structure:

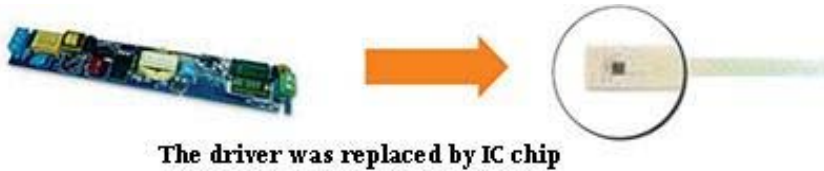

The driver was replaced by IC chip

5. Installation

1. Inductive Fixture (Magnetic Ballast)

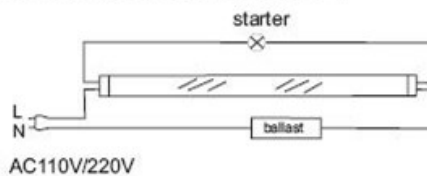

A: Traditional fluorescent tube with inductive fixture. (Magnetic Ballast)

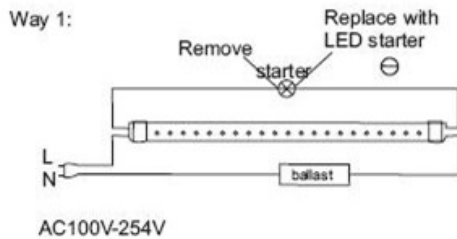

Turn off the power, remove fluorescent tube remove fluorescent starter and replace with LED starter. Place LED tube into position.

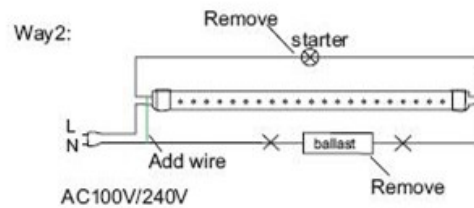

Turn off the power, remove fluorescent tube and fluorescent starter. Bypass magnetic ballast(Qualified Electrician ONLY). Replace with LED tube.

2. Electronic Fixture (Electronic Ballast)

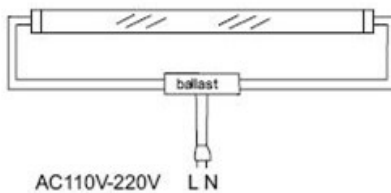

B: Traditional fluorescent tube with electronic fixture. (Electronic Ballast)

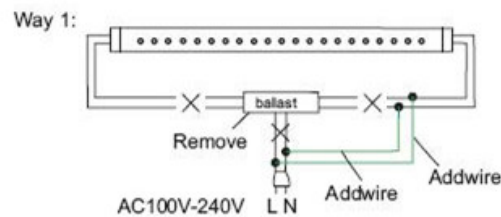

Turn off the power, remove fluorescent tube. Qualified Electrician needs to bypass or remove the electronic ballast, reconnect for single ended power input, and then replace with LED tube.

6. Packing details

Part No.	Package dimension	Gross Weight
T8-120	1250X210X215mm, 25pcs/carton	10.80kg

Corrugated carton + EPE cotton



7. Applications

Direct replacement for conventional fluorescent light, applicable to Indoor lighting such as home, villa, restaurant, hotel, lobby, show room, shop window, conference and meeting rooms, factories and offices, institution buildings, underground parking area, schools, colleges & universities, hospitals, places where there is a need for energy saving and high color rendering index lighting.

